

# Data Sheet



Article number: 5863503812

Description: Ball Valve 350.3812, G 1" - G 1"  
Thread/Thread

## Measures

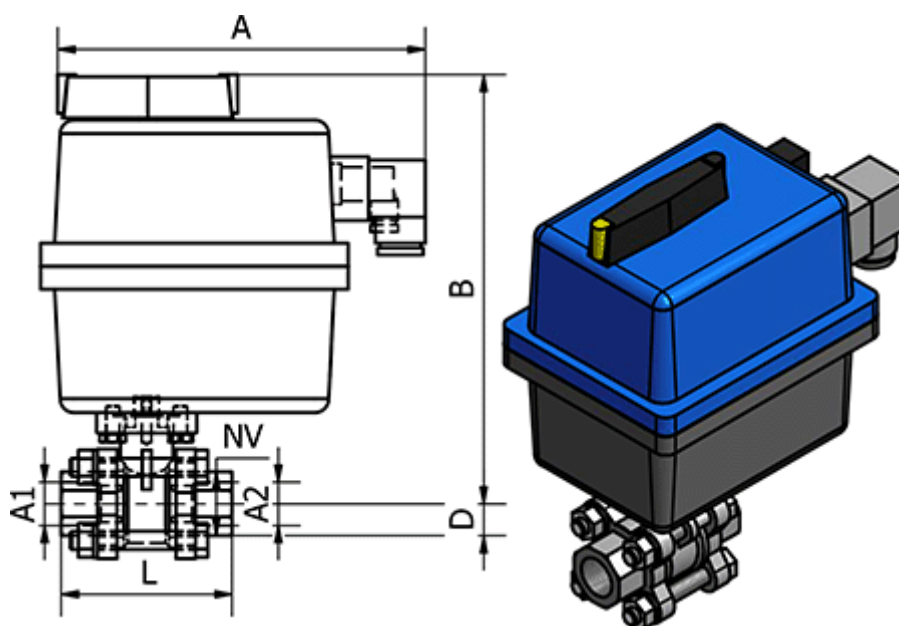

= -	Connecting A2	= G 1"
= -	D	= 33
= -	L	= 82
= -	Max. Operating Pressure	= 40 bar
= -	NV	= 41

A = 177

B = 195

Connecting A1 = G 1"